

4COLORS

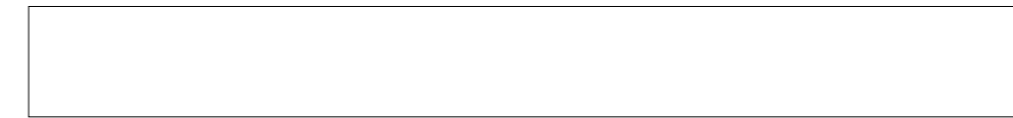

4SIZES



20x180 RT | 8"x72"
✂ 9,5mm | R9 A

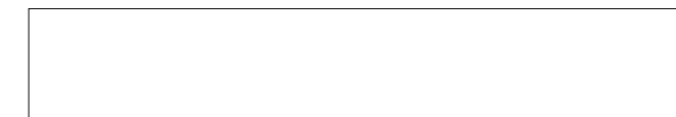
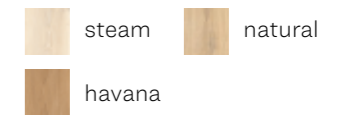

20x120 RT | 8"x48"
✂ 9mm | R9 A

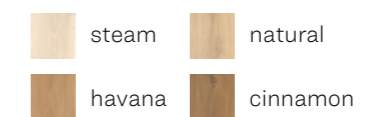

20x120 RT | 8"x48"
✂ 9mm | saw cut

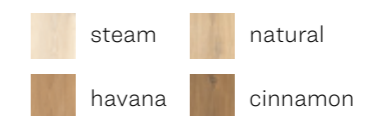

20x120 RT | 8"x48"
✂ 9mm | *grip R11 C

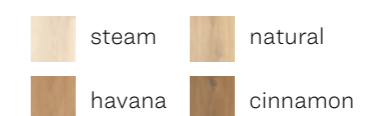

* finitura grip disponibile su richiesta
grip finish available upon request
finition grip disponible sur demande
Griffausführung auf Anfrage erhältlich



7,5x60 | 3"x24"
✂ 8,5mm | R9 A

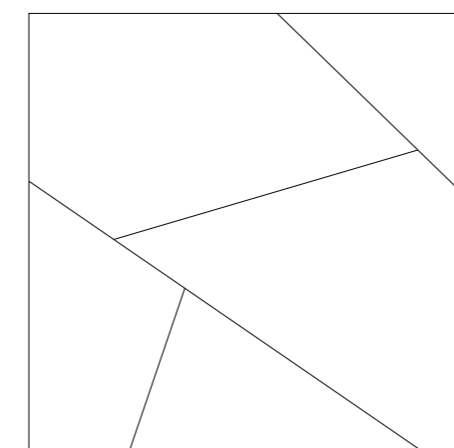
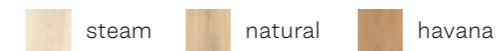

Tangram 80x80 RT | 32"x32"
✂ 9mm

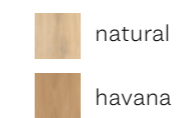



STEAM

GRES PORCELLANATO | PORCELAIN TILE | GRÈS CÉRAME | FEINSTEINZEUG

R9 A | 20x120 RT | 20x180 RT | 7,5x60

*GRIP R11 C | 20x120 RT

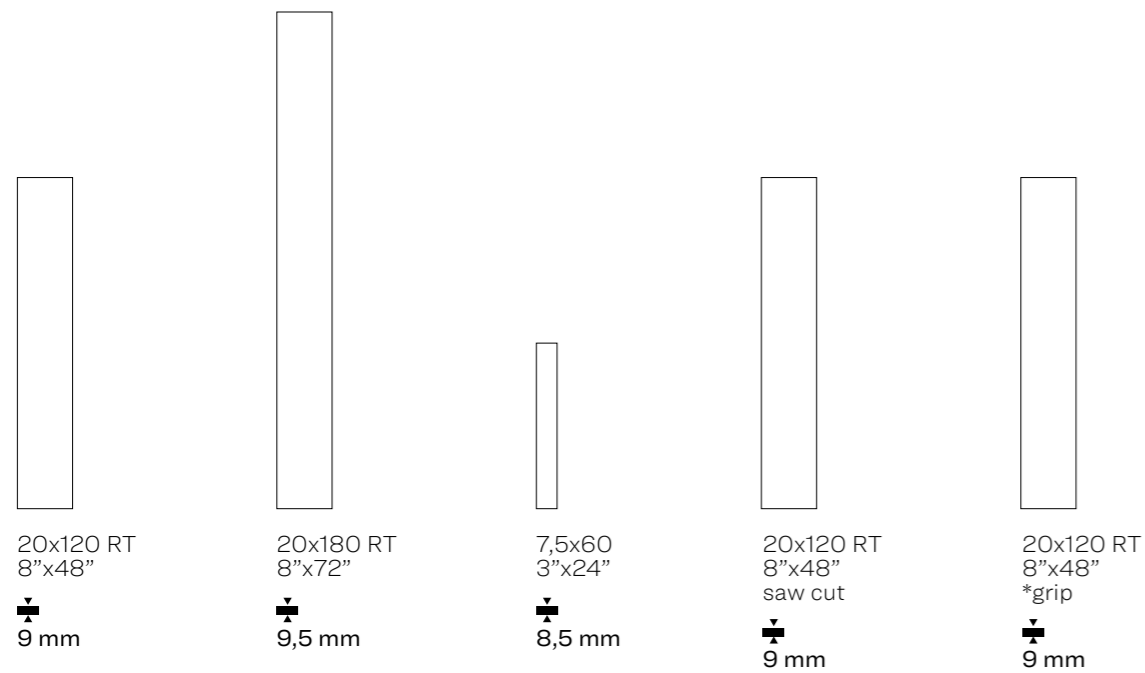

*
finitura grip disponibile su richiesta
grip finish available upon request
finition grip disponible sur demande
Griffausführung auf Anfrage erhältlich

NATURAL

GRES PORCELLANATO | PORCELAIN TILE | GRÈS CÉRAME | FEINSTEINZEUG

R9 A | 20x120 RT | 20x180 RT | 7,5x60

*GRIP R11 C | 20x120 RT

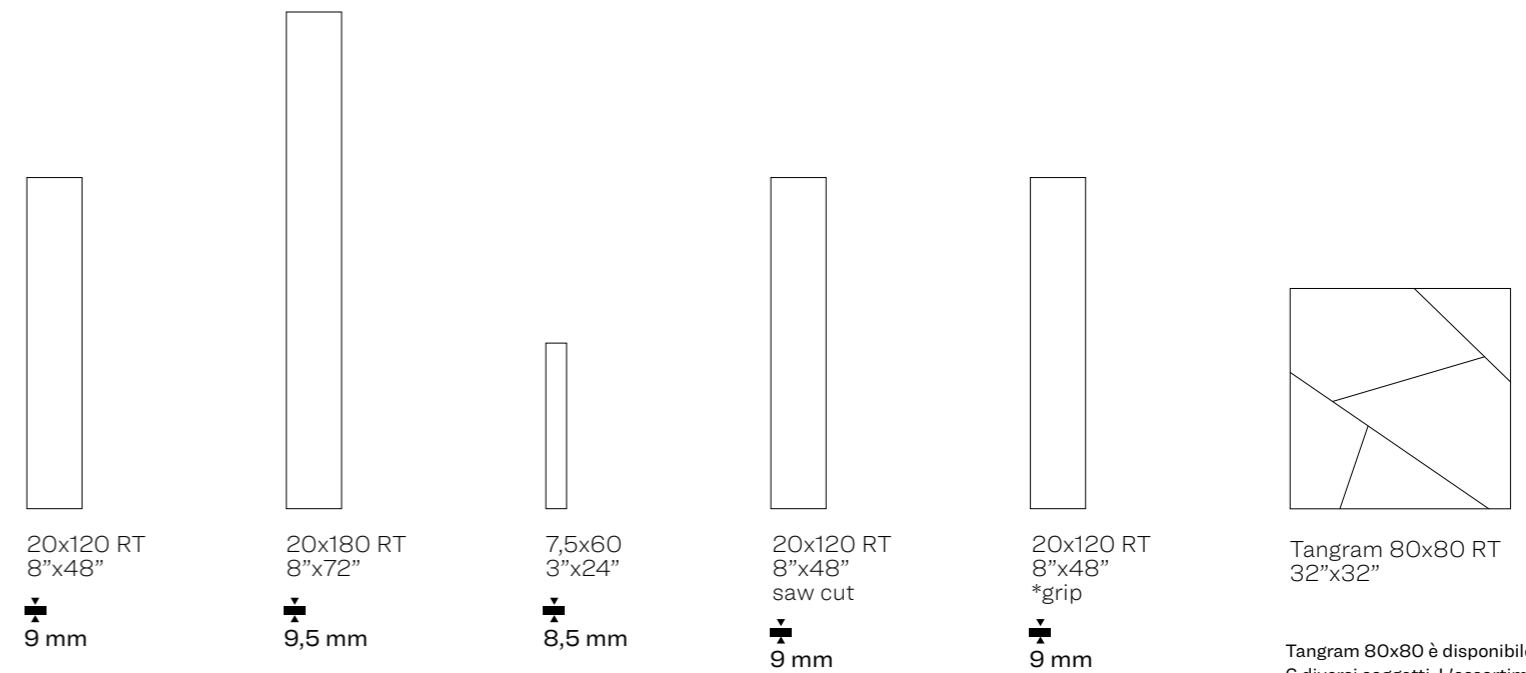

Tangram 80x80 è disponibile in
6 diversi soggetti. L'assortimento
all'interno delle scatole è casuale.
6 different types of graphics, 80x80
size. The assortment in the box is
random.



HAVANA

GRES PORCELLANATO | PORCELAIN TILE | GRÈS CÉRAME | FEINSTEINZEUG

R9 A | 20x120 RT | 20x180 RT | 7,5x60

*GRIP R11 C | 20x120 RT

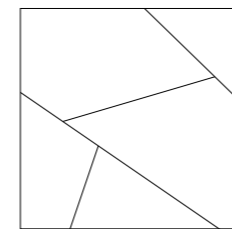
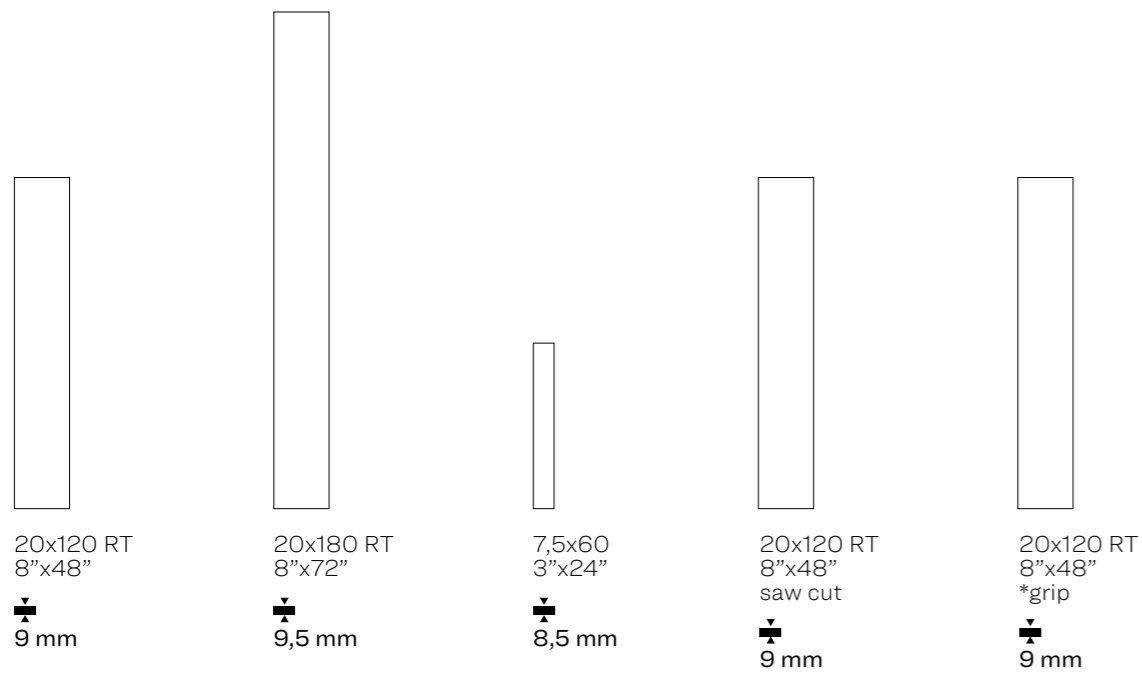

Tangram 80x80 RT
32"x32"

Tangram 80x80 è disponibile in 6 diversi soggetti. L'assortimento all'interno delle scatole è casuale. 6 different types of graphics, 80x80 size. The assortment in the box is random.

CINNAMON

GRES PORCELLANATO | PORCELAIN TILE | GRÈS CÉRAME | FEINSTEINZEUG

R9 A | 20x120 RT | 20x180 RT | 7,5x60

*GRIP R11 C | 20x120 RT

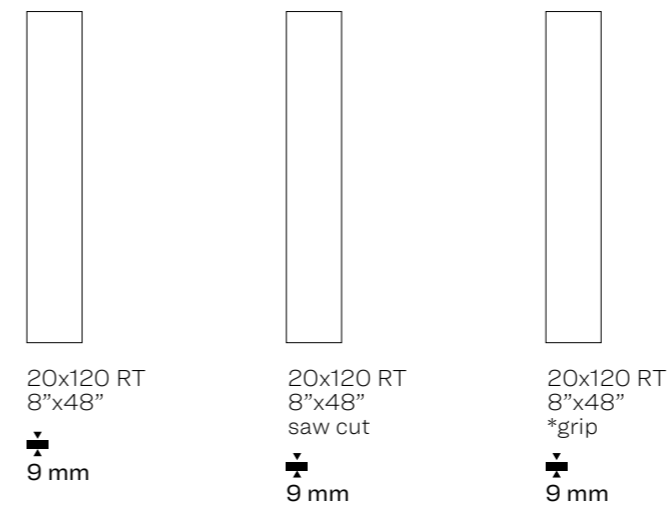

* finitura grip disponibile su richiesta
grip finish available upon request
finition grip disponible sur demande
Griffausführung auf Anfrage erhältlich

PEZZI SPECIALI | SPECIAL TILES | PIÈCES SPÉCIALES | FORMTEILE

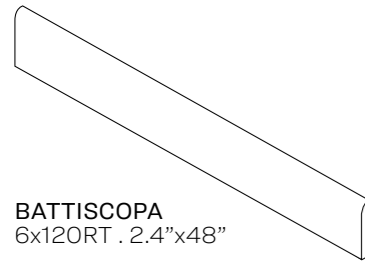

BATTISCOPA
6x120RT . 2.4"x48"

IMBALLI | EMBALLAGE | VERPACKUNG | PACKING

| | pz/box | mq/box | kg/box | box/plt | mq/plt | kg/plt | spessore |
|---------------------|--------|--------|--------|---------|--------|--------|----------|
| 20x180RT | 5 | 1,80 | 38,00 | 40 | 72,00 | 1535 | 9,5 mm |
| 20x120RT | 6 | 1,44 | 26,70 | 32 | 46,08 | 867 | 9 mm |
| 20x120RT saw cut | 6 | 1,44 | 26,70 | 32 | 46,08 | 867 | 9 mm |
| 7,5x60 | 22 | 0,99 | 19,00 | 60 | 59,40 | 1155 | 8,5 mm |
| 80x80RT | 2 | 1,28 | 25,50 | 48 | 61,44 | 1239 | 9 mm |
| 6x120 battiscopa TD | 8 | 9,6 ml | 12,00 | - | - | - | - |

AVVERTENZE PER LA POSA | RECOMMENDATIONS FOR INSTALLATION RECOMMANDATIONS POUR LA POSE | VERLEGETIPPS

Per la posa del materiale rettificato si prescrive una fuga minima di 2 mm . As for rectified materials, a minimum joint of 2 mm is required . Pour la pose du matériau rectifié, il faut réaliser un joint minimum de 2 mm . Für die Verlegung des geschliffenen Materials ist eine Mindestfuge von 2 mm vorgeschrieben .

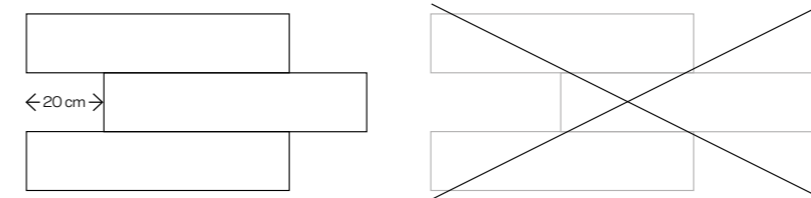

Si raccomanda di posare i materiali sfalsati di 20 cm al massimo, mai a metà della loro lunghezza . It is strongly recommended to install the materials in a staggered pattern of a maximum of 20 cm, never at half way its length . Il est conseillé de poser les matériaux en décalé de 20 cm au maximum, jamais à la moitié de leur longueur . Es wird empfohlen, die Materialien um höchstens 20 cm versetzt zu verlegen und nie in der Mitte ihrer Länge

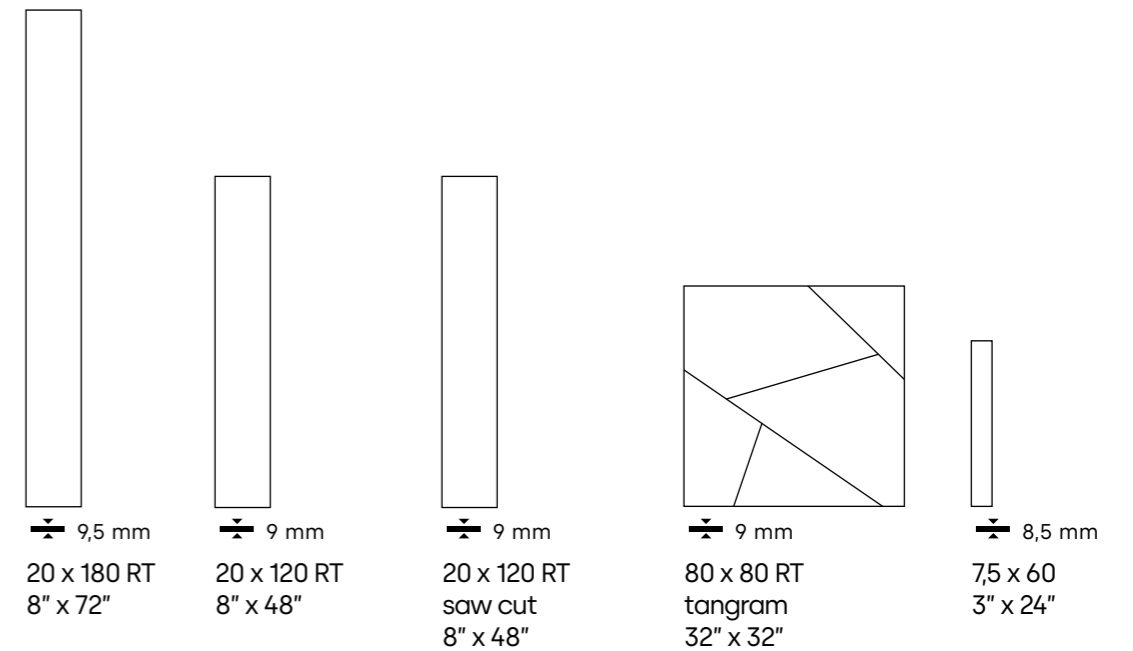

| | | | | | |
|----------|---|---|---|---|---|
| STEAM | ☑ | ☑ | ☑ | | ☑ |
| NATURAL | ☑ | ☑ | ☑ | ☑ | ☑ |
| HAVANA | ☑ | ☑ | ☑ | ☑ | ☑ |
| CINNAMON | | ☑ | ☑ | | |

GRIP R11 C
su richiesta
on demand

☑ R9 A